



Item: _____
 Quantity: _____
 Project: _____
 Approval: _____
 Date: _____

Models:

- SUME-100 SUME-200



Model SUME-100

Standard Features:

- Solid State control with electro-mechanical timer
- Two-speed fan control (high and low) with 3/4 HP fan motor
- Total of 10.4 kW loading per oven cavity
- Stainless steel front, sides, top, and legs
- 60/40 dependent door design with double pane thermal window in left-hand door and interior lighting
- Porcelain enameled oven interior with coved corners
- Five (5) chrome plated oven racks on 10-position rack guides
- Full length, stainless steel positive door closure
- Double deck models available

- One year limited parts and labor warranty (USA and Canada only)
- Five year limited door warranty, excluding window (USA and Canada only)

Optional Features:

- Windows in both doors
- Stainless steel solid doors
- Extra oven racks
- Swivel casters, (4) w/ front brakes
- Low profile casters, (4) w/ front brakes (double ovens only)
- Open base with rack guides and shelf (stainless steel)
- Back enclosure (stainless steel)
- 460 volt, three phase

Specifications:

U.S. Range Summit Full-Size Standard Depth, electric convection oven. 10.4 kW / cavity, 3/4 HP fan motor with two-speed fan speed. Solid Satet Control with 60-minute timer. Porcelain enameled oven interior with coved corners, five (5) oven racks and 10-position rack guides. All model interiors are 29" (736mm) W by 24" (610mm) H, depth is 24" (610mm). Stainless steel front, sides, top, and legs. 60/40 dependent door design with double pane thermal window in left-hand door and interior lighting. 200 models are double deck units. UL, CUL Classified and NSF Listed.



Note: Ovens supplied with casters must be installed with an approved restraining device.



Model	Int. Dimensions :In (mm)			Ext. Dimensions: In (mm)			Ship Wt	Ship Dim.
	W	H	D	W	H**	D (w/motor)	Lbs/kg	Cubic Ft.
SUME-100	29 (736)	24 (610)	24 (610)	38 (965)	57-1/2 (1461)	41-1/4 (1048)	750/341	80
SUME-200	29(736)	24(610)	24(610)	38(965)	70-1/2 (1791)	41-1/4 (1048)	1500/682	160

** Height with or without with standard casters. Height with low profile casters (double deck) is 68-1/2" (1740mm).

Model	Tota kW	Nominal Amperes Per Line, (includes 3/4 HP fan motor)										
		208V/1Ph	240V/1Ph	208V/3Ph			240V/3Ph			460V/3Ph		
				X	Y	Z	X	Y	Z	X	Y	Z
Single Deck	10.4	50	43	30	30	28	26	26	24	14	14	13
Double Deck* each oven	10.4	50	43	30	30	28	26	26	24	14	14	13

* Double Deck Models require individual power supply connections

Electrical specifications include motor requirements. 3/4, HP, 2-speed motor: 1725/1140 rpm, (60Hz); or 1440/950 rpm (50Hz)
Please specify electrical characteristics when ordering.

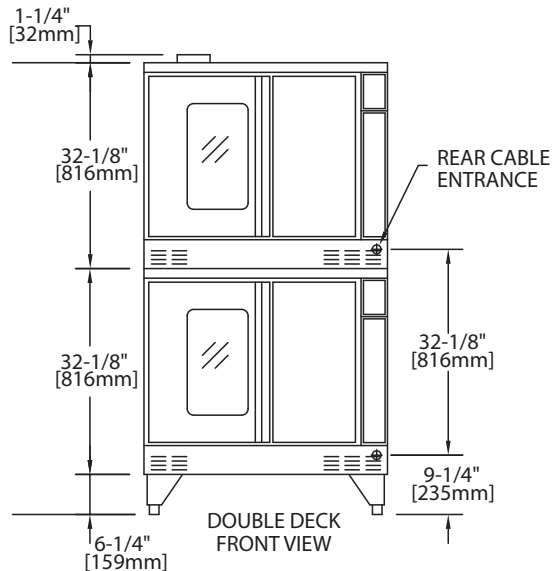
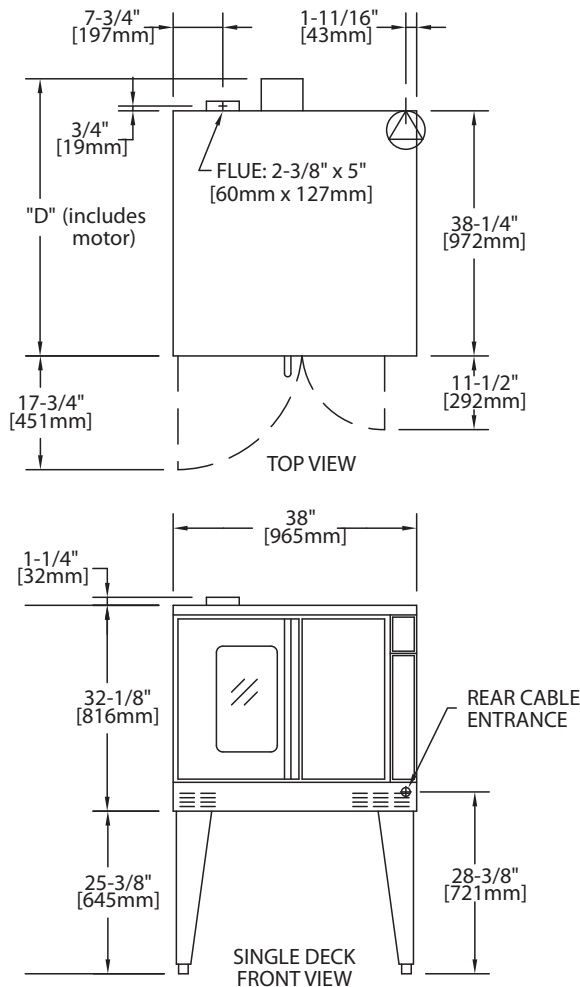

Installation Notes:			
Combustible & Non-Combustible Wall Clearances:			
Sides	1" (25mm)	Back	3" (76mm)
Entry Clearances: In (mm)			
Crated	44-1/2 (1130)	Uncrated	32-1/2 (826)

Many local codes exist and it is the responsibility of the owner and installer to comply with those codes.

These appliances are intended for commercial use by professionally trained personnel.

Form# SUME (03/21/14)